

# Rocktech Displays Limited



Module P/N: RK050BN65

Version: 1.0

Description : 5.0 inch TFT 480\*272 Pixels with  
LED backlight,350 nits brightness

TEL: 0086-755-26065260

Fax: 0086-755-26065261

E-mail: [Sales@rocktech.com.hk](mailto:Sales@rocktech.com.hk)

Web: [www.rocktech.com.hk](http://www.rocktech.com.hk)

**Revision History**

<b>Date</b>	<b>Rev.</b>	<b>Page</b>	<b>Description</b>
<b>2017-06-23</b>	<b>1.0</b>	<b>All</b>	<b>First issue</b>

# CONTENTS

- GENERAL FEATURES
- ABSOLUTE MAXIMUM RATINGS
- ELECTRICAL SPECIFICATIONS
- OPTICAL SPECIFICATIONS
- BLOCK DIAGRAM
- PIN DESCRIPTION
- TIMING CHARACTERISTICS
- OUTLINE DIMENSION
- RELIABILITY AND INSPECTION STANDARD
- PRECAUTIONS

**1. General Features**

<b>Item</b>	<b>Spec</b>	<b>Remark</b>
Display Mode	Normally White transmissive	
Viewing Direction	12 O'CLOCK	
Input Signals	RGB 24 bit	
Outside Dimensions	120.70 (W) x75.80(H) x3.00(D)	
Active Area	110.88mm(W)×62.83mm(H)	
Number of Pixels	480(RGB)×272	
Dot Pitch	0.2310(W) ×0.2310mm(H)	
Pixel Arrangement	RGB Vertical stripes	
Drive IC	HX8257A-M	

## 2. Absolute Maximum Ratings

The following are maximum values which, if exceeded may cause operation or damage to the unit.

ITEM	Sym.	Min.	Typ.	Max.	Unit	Remark
Power for Circuit Driving	VDD	-0.3	-	4.6	V	
Power for Circuit Logic	Vt	-0.3	-	VDD+0.3	V	
Storage Humidity	H <sub>ST</sub>	10	-		%RH	At 25±5°C
Storage Temperature	T <sub>ST</sub>	-30	-	80	°C	
Operating Ambient Humidity	H <sub>OP</sub>	10	-		%RH	
Operating Ambient temperature	T <sub>OP</sub>	-20	-	70	°C	

### 3. Electrical Specification

#### 3.1 Driving TFT LCD Panel

Item		Sym.	Min	Typ.	Max	Unit	Note
Power for Circuit Driving		VDD	3.0	3.3	3.6	V	
Logic Input Voltage	Low Voltage	V <sub>IL</sub>	0	-	0.3VDD	V	
	High Voltage	V <sub>IH</sub>	0.7VDD	-	VDD	V	
Logic Output Voltage	Low Voltage	V <sub>OL</sub>	0	-	0.2VDD	V	
	High Voltage	V <sub>OH</sub>	0.8VDD	-	-	V	

#### 3.2 Driving Backlight

Item	Sym.	Min	Typ.	Max	Unit	Note
Backlight driving voltage	V <sub>F</sub>	-	19.2	-	V	
Backlight driving current	I <sub>F</sub>	30	40	50	mA	
Backlight Power Consumption	W <sub>BL</sub>	-	768	-	mW	
Life Time	-	-	50,000	-		Note 3

Note 1: (Unless specified, the ambient temperature  $T_a=25^{\circ}\text{C}$ )

Note 2: The recommended operating conditions refer to a range in which operation of this product is guaranteed. Should this range is exceeded, the operation cannot be guaranteed even if the values may be without the absolute maximum ratings.

Note 3: If LED is driven by high current, high ambient temperature & humidity condition. The life time of LED will be reduced. Operating life means brightness goes down to 50% initial brightness. Typical operating life time is estimated data.

## 4. Optical Specifications

Optical characteristics are determined after the unit has been 'ON' and stable for approximately 30 minutes in a dark environment at 25 °C. The values specified are at an approximate distance 500mm from the LCD surface at a viewing angle of  $\Phi$  and  $\theta$  equal to 0°.

Item	Sym.	Values			Unit	Note
		Min.	Typ.	Max.		
1) Contrast Ratio	C/R	400	500	-		FIG.1
2) Module Luminance	L	300	350	-	cd/m <sup>2</sup>	FIG.1
3) Response time	Tr+Tf	-	20	-	ms	FIG.2
4) Viewing Angle	$\theta_T$	60	70	-	Degree	FIG.3
	$\theta_B$	40	50	-		
	$\theta_L$	60	70	-		
	$\theta_R$	60	70	-		
5) Chromaticity	Wx	0.275	0.315	0.355		
	Wy	0.295	0.335	0.375		
	Rx	-	-	-		
	Ry	-	-	-		
	Gx	-	-	-		
	Gy	-	-	-		
	Bx	-	-	-		
	By	-	-	-		

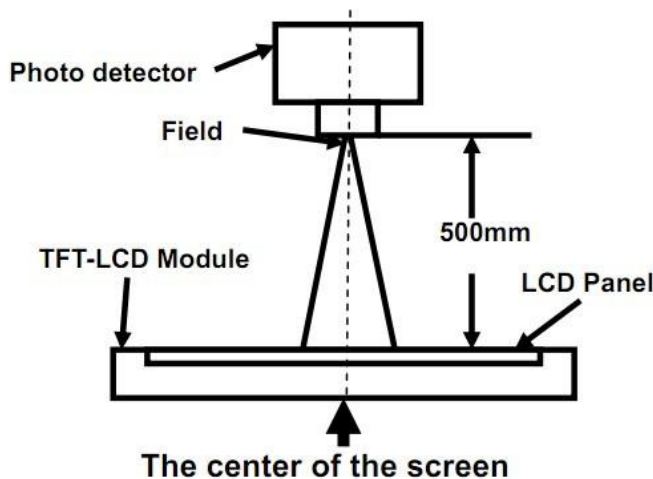
## ◆ Measurement System

Notes:

1. Contrast Ratio(CR) is defined mathematically as :  

$$\text{Contrast Ratio} = \frac{\text{Surface Luminance with all white pixels}}{\text{Surface Luminance with all black pixels}}$$
2. Surface luminance is the center point across the LCD surface 500mm from the surface with all pixels displaying white. For more information see FIG 1.
3. Response time is the time required for the display to transition from white to black (Rising Time, Tr) and from black to white (Falling Time, Tf). For additional information see FIG 2.
4. Viewing angle is the angle at which the contrast ratio is greater than 10. The angles are determined for the horizontal or x axis and the vertical or y axis with respect to the z axis which is normal to the LCD surface. For more information see FIG 3.

**FIG. 1 Optical Characteristic Measurement Equipment and Method**



Item	Photo detector	Field
Contrast Ratio	SR-3A	1°
Luminance		
Chromaticity		
Lum Uniformity	BM-7A	2°
Response Time		

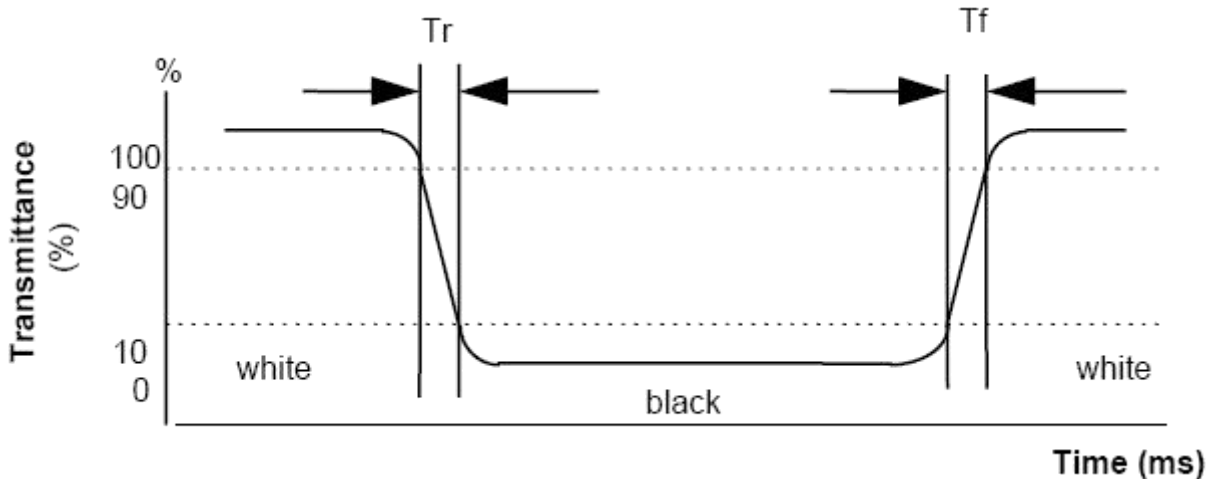


**FIG. 2 The definition of Response Time**

The response time is defined as the following figure and shall be measured by switching the input signal for “black” and “white”.

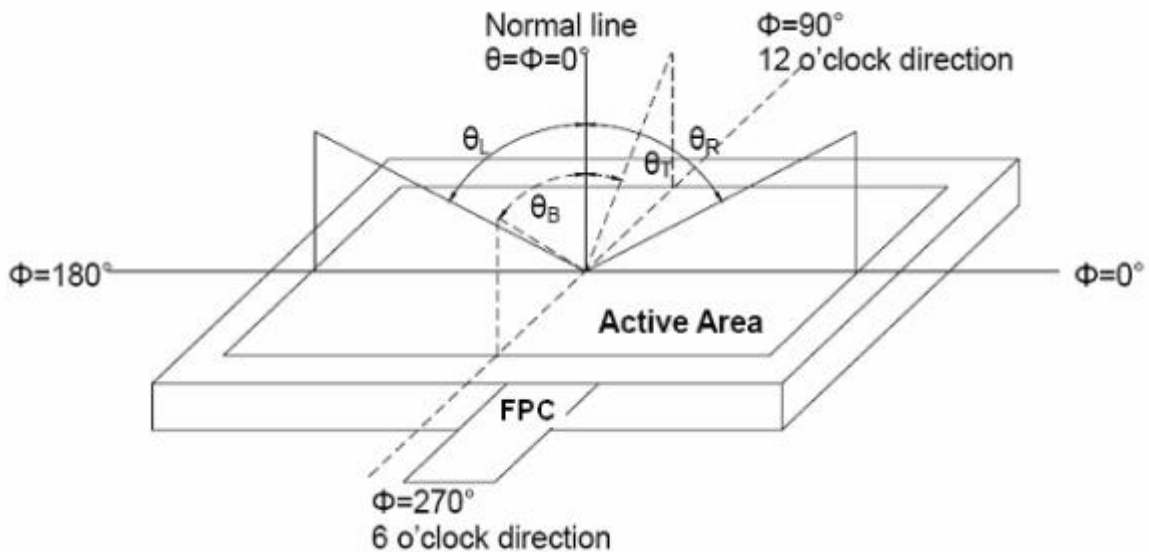
$$\text{Response Time} = \text{Rising Time}(Tr) + \text{Falling Time}(Tf)$$

- Rising Time( $T_r$ ) : Full White 90%  $\rightarrow$  Full White 10% Transmittance.
- Falling Time( $T_f$ ) : Full White 10%  $\rightarrow$  Full White 90% Transmittance.

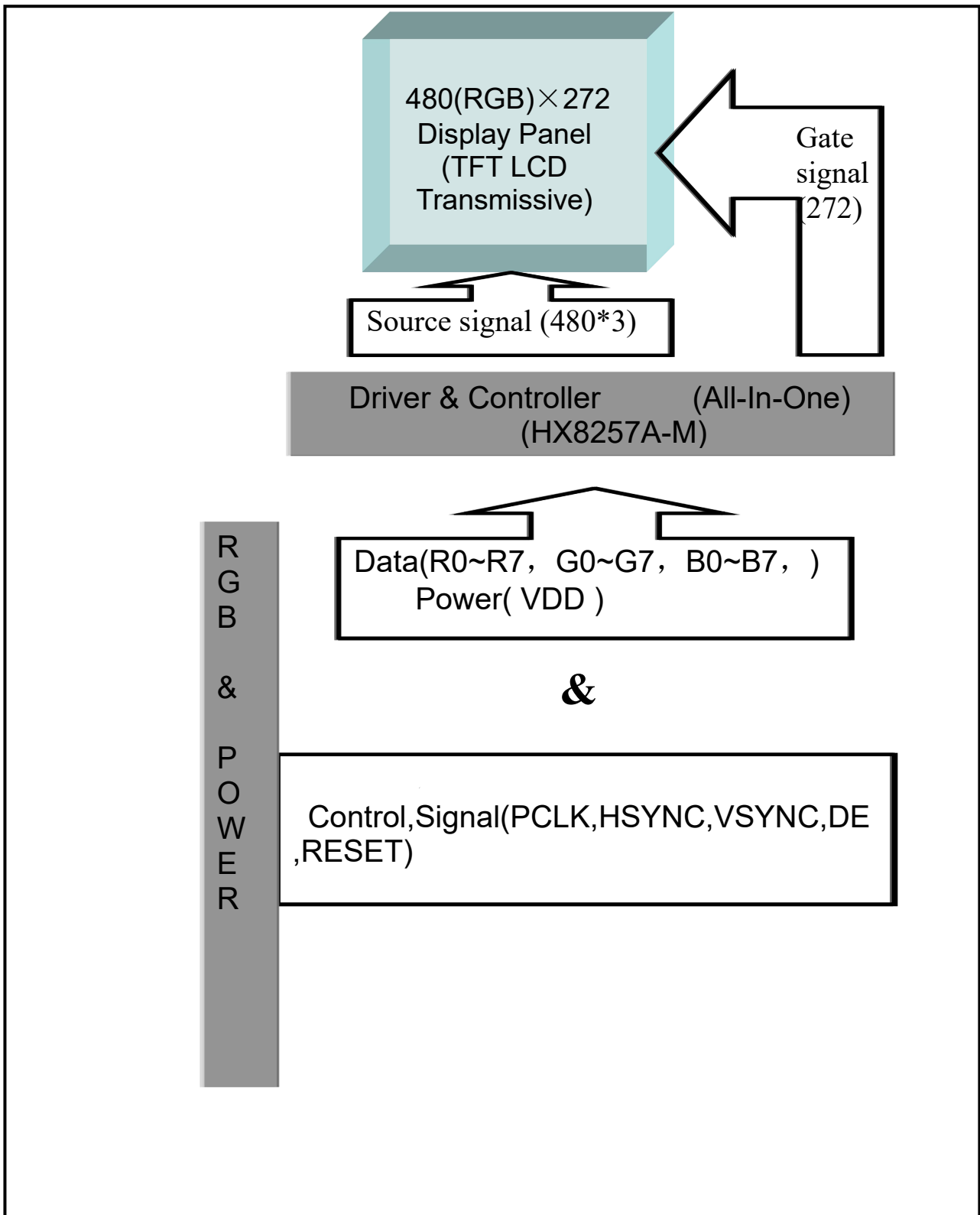


**FIG. 3 The definition of Viewing Angle**

Use Fig. 1 (Test Procedure) under Measurement System to measure the contrast from the measuring direction specified by the conditions as the following figure.



## 5. Block Diagram



## 6.Pin Description

Item	Symbol	Description
1	LEDK	B/L Power input PIN Cathode
2	LEDA	B/L Power input PIN anode
3	GND	Ground
4	VDD	Power input
5--12	R0—R7	Red Data
13--20	G0--G7	Green Data
21--28	B0—B7	Blue Data
29	GND	Ground
30	DCLK	Data clock signal
31	DISP	Standby Mode DISP="1", Normal operation DISP="0", Standby mode.
32	NC	No Connection
33	NC	No Connection
34	DE	Data ENABLE signal
35	NC	NC
36	GND	Ground
37	XR(NC)	Touch panel right side(NC if without TP)
38	YD(NC)	Touch panel below side(NC if without TP)
39	XL(NC)	Touch panel left side(NC if without TP)
40	YU(NC)	Touch panel up side(NC if without TP)

## 7. Timing Characteristics

### 7.1 Input Setup Timing setting

#### 7.1.1 Input Setup Timing setting

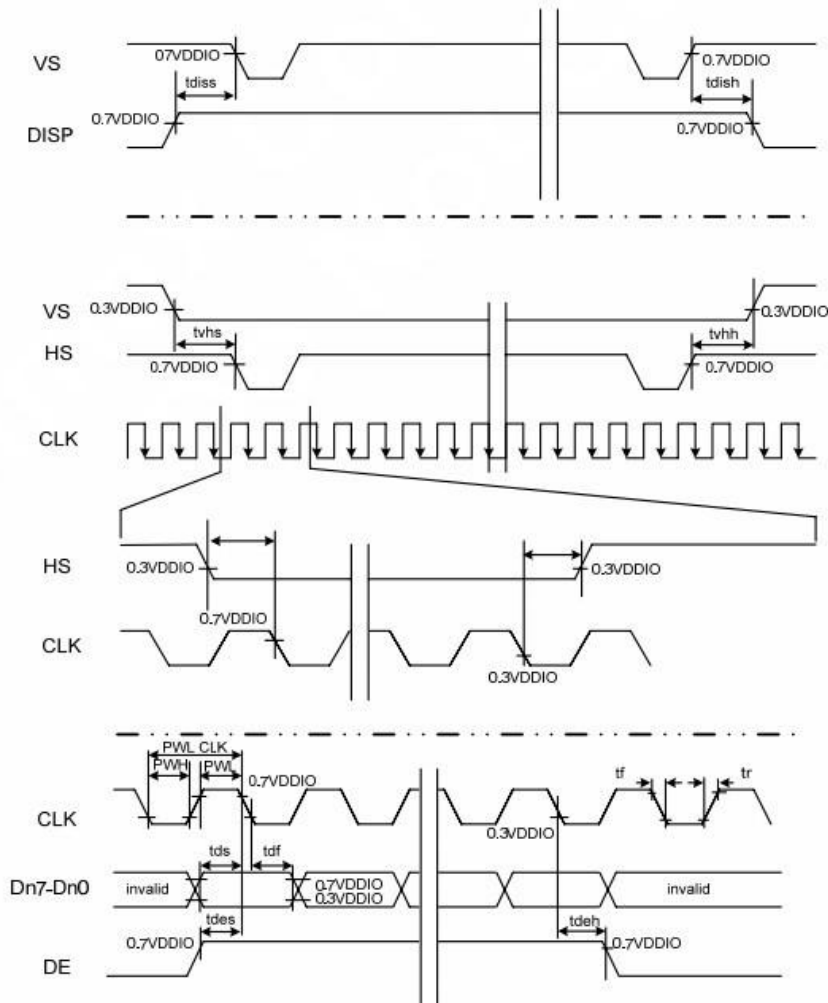
( $T_A=25^{\circ}\text{C}$ ,  $V_{DDIO}=1.8\text{V to }3.6\text{V}$ ,  $DVSS=0\text{V}$ ,  $t_r^{(1)}=t_f^{(1)}=2\text{ns}$ )

Parameter	Symbol	Spec.			Unit
		Min.	Typ.	Max.	
DISP setup time	$t_{diss}$	10	-	-	ns
DISP hold time	$t_{dish}$	10	-	-	ns
Clock period	$PW_{CLK}^{(2)}$	66.7	-	-	ns
Clock pulse high period	$PWH^{(2)}$	26.7	-	-	ns
Clock pulse low period	$PWL^{(2)}$	26.7	-	-	ns
Hsync setup time	$t_{hs}$	10	-	-	ns
Hsync hold time	$t_{hh}$	10	-	-	ns
Data setup time	$t_{ds}$	10	-	-	ns
Data hold time	$t_{dh}$	10	-	-	ns
DE setup time	$t_{des}$	10	-	-	ns
DE hold time	$t_{deh}$	10	-	-	ns
Vsync setup time	$t_{vhs}$	10	-	-	ns
Vsync hold time	$t_{vhh}$	10	-	-	ns

**Note:** (1)  $t_r$ ,  $t_f$  is defined 10% to 90% of signal amplitude.

(2) For parallel interface, maximum clock frequency is 15MHz.

#### 7.1.2 Input setup Timing Diagram



## 7.2 Data Input Format

### 7.2.1 Data Input Timing Parameter Setting

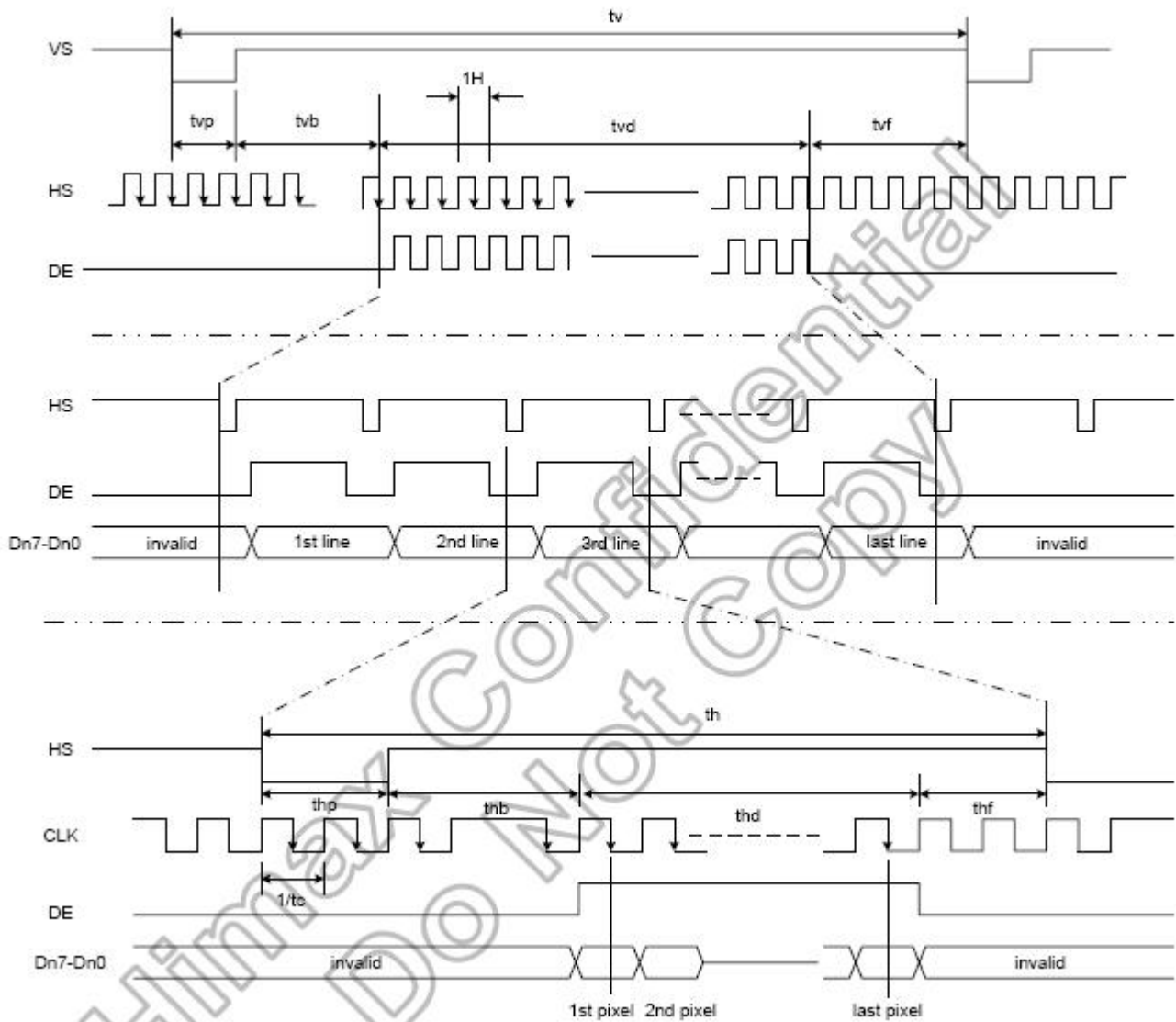
(480RGBx272,  $T_A=25^{\circ}\text{C}$ ,  $V_{DDIO}=1.8\text{V}$  to  $3.6\text{V}$ ,  $DVSS=0\text{V}$ )

Parameter	Symbol	Spec.			Unit
		Min.	Typ.	Max.	
Clock cycle	$f_{\text{CLK}}^{(1)}$	-	9	15	MHz
Hsync cycle	1/th	-	17.14	-	KHz
Vsync cycle	1/tv	-	59.94	-	Hz
Horizontal Signal					
Horizontal cycle	th	525	525	605	CLK
Horizontal display period	thd	480	480	480	CLK
Horizontal front porch	thf	2	2	82	CLK
Horizontal pulse width	thp <sup>(2)</sup>	2	41	41	CLK
Horizontal back porch	thb <sup>(2)</sup>	2	2	41	CLK
Vertical Signal					
Vertical cycle	tv	285	286	399	H <sup>(1)</sup>
Vertical display period	tvd	272	272	272	H <sup>(1)</sup>
Vertical front porch	tvf	1	2	227	H <sup>(1)</sup>
Vertical pulse width	tvp <sup>(2)</sup>	1	10	11	H <sup>(1)</sup>
Vertical back porch	tvb <sup>(2)</sup>	1	2	11	H <sup>(1)</sup>

**Note:** (1) Unit: CLK=1/  $f_{\text{CLK}}$ , H= th,

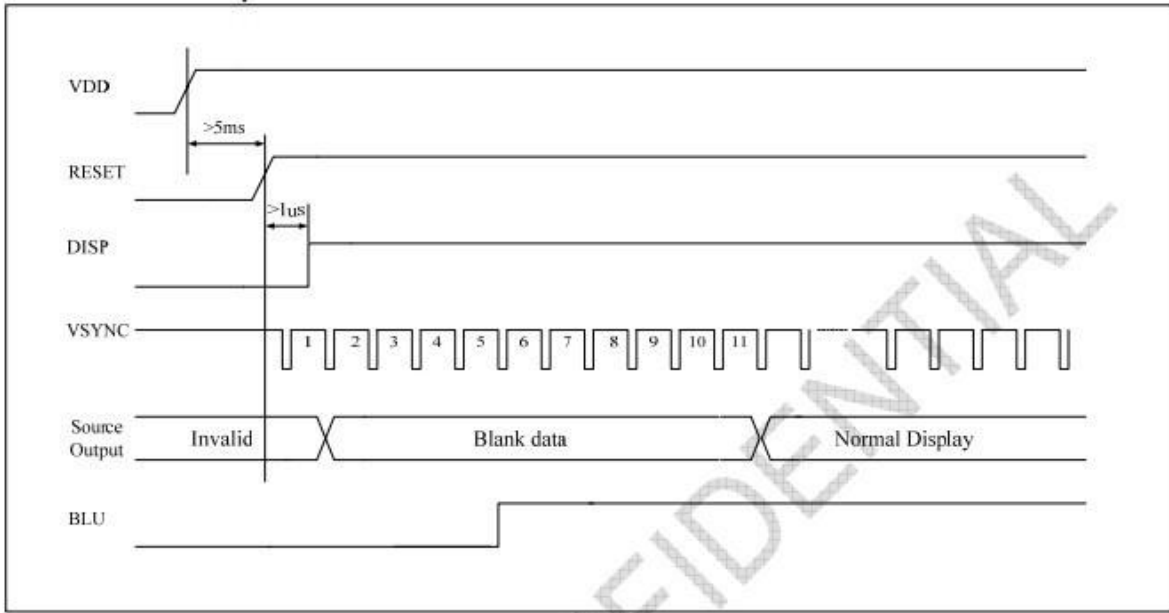
(2) It is necessary to keep  $tvp+tvb=12$  and  $thp+thb=43$  in sync mode. DE mode is unnecessary to keep it.

## 7.2.2 Data Input Timing Diagram Data Input Timing Diagram under SYNC Mode

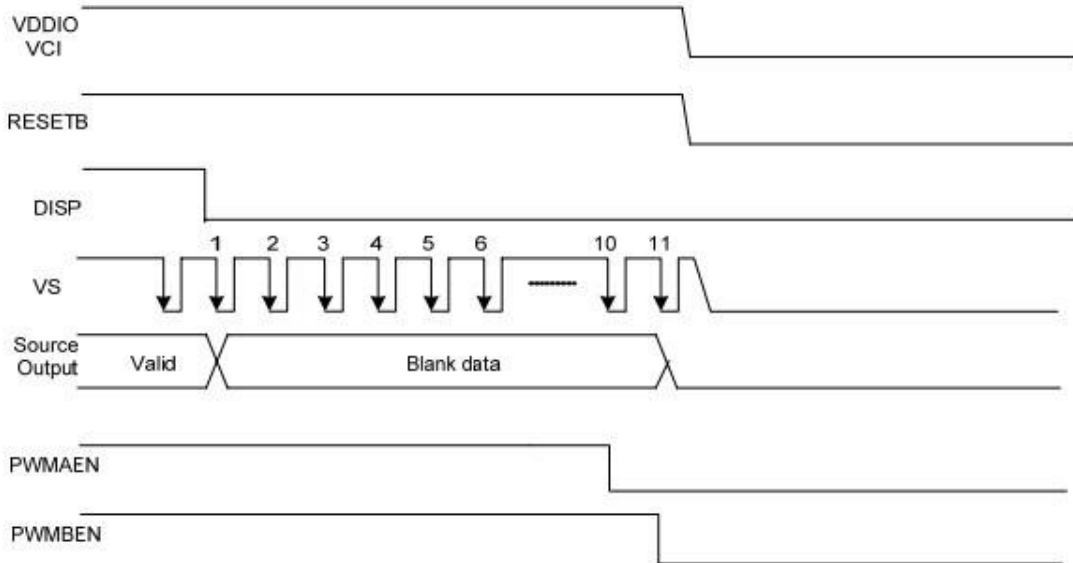


## 7.3 Power on/off Sequence

### 7.3.1 Power On Sequence



### 7.3.2 Power Off Sequence



## 8.Outline Dimension

Display Type	Transmissive, Normally White	Display Resolution	480(RGB)*272
Viewing Angle	12:00	LCD Controller/Driver	HX8257A-M
LCD Driving Voltage	3.3V	Operation Temperature	-20°C TO 70°C
Storage Temperature	-30°C TO 80°C	Backlight Speciality	LED Side(White; 12PCS DIES); V <sub>F</sub> =1.92V; I <sub>F</sub> =40mA
Remark	FPC Connector (FH12-40S-0.5SH) All materials in the drawing comply with the ROHS		

ISSUE	MODIFY DESCRIPTION	DATE
1.0	First Issue	2017.06.23

TITLE:	LCM Outline
PROJECT NO.:	RK050BN65
DESCRIPTION:	5.0 Inch TFT
General Tolerance: ±0.2	

Rocktech Displays Limited		
THIRD ANGLE PROJECTION		
NAME	SIGN	DATE
DRAWN Marvin Zhou		2017.06.23
CHECKED Marvin Zhou		2017.06.23
REV.: 1.0	UNIT: mm	SCALE: 1/1
		SHEET: 1 OF 1

TFT ASSIGNMENT:	
PIN	SYMBOL
1	ENH
2	ENH
3	ENH
4	ENH
5	ENH
6	BT
7	BT
8	BT
9	BT
10	BT
11	BT
12	BT
13	BT
14	BT
15	BT
16	BT
17	BT
18	BT
19	BT
20	BT
21	BT
22	BT
23	BT
24	BT
25	BT
26	BT
27	BT
28	BT
29	BT
30	BT
31	BT
32	BT
33	BT
34	BT
35	BT
36	BT
37	BT
38	BT
39	BT
40	BT



## 9. Reliability and Inspection Standard

No.	Test Item		Test Conditions	Remark
1	High Temperature	Storage	80°C, 120Hr	Note
		Operation	70°C, 120Hr	Note
2	Low Temperature	Storage	-30°C, 120Hr	Note
		Operation	-20°C, 120Hr	
3	High Temperature and High Humidity		40°C, 90%RH, 120Hr	Note
4	Thermal Cycling Test(No operation)		-20°C for 30min, 70°C for 30 min. 100 cycles. Then test at room temperature after 1 hour	Note
5	Vibration Test(No operation)		Frequency :10~55 HZ; Stroke :1.5 mm;Sweep:10HZ~55HZ~10HZ; 2hours for each direction of X, Y, Z(6 hours for total)	
6	Package Drop Test		Height:60 cm,1 corner, 3 edges, 6 surfaces	
7	Electro Static Discharge		±2KV,Human Body Mode, 100pF/1500Ω	

Note:

- 1) Sample quantity for each test item is 5~10pcs.
- 2) Note 4: Before cosmetic and function test, the product must have enough recovery time, at least 2 hours at room temperature.

## 10. PRECAUTIONS FOR USING LCD MODULES

### Handling Precautions

- (1) The display panel is made of glass and polarizer. As glass is fragile, it tends to become or chipped during handling especially on the edges. Please avoid dropping or jarring. Do not subject it to a mechanical shock by dropping it or impact.
- (2) If the display panel is damaged and the liquid crystal substance leaks out, be sure not to get any in your mouth. If the substance contacts your skin or clothes, wash it off using soap and water.
- (3) Do not apply excessive force to the display surface or the adjoining areas since this may cause the color tone to vary. Do not touch the display with bare hands. This will stain the display area and degraded insulation between terminals (some cosmetics are determined to the polarizer).
- (4) The polarizer covering the display surface of the LCD module is soft and easily scratched. Handle this polarizer carefully. Do not touch, push or rub the exposed polarizers with anything harder than an HB pencil lead (glass, tweezers, etc.). Do not put or attach anything on the display area to avoid leaving marks on. Condensation on the surface and contact with terminals due to cold will damage, stain or dirty the polarizer. After products are tested at low temperature they must be warmed up in a container before coming in contact with room temperature air.
- (5) If the display surface becomes contaminated, breathe on the surface and gently wipe it with a soft dry cloth. If it is heavily contaminated, moisten cloth with one of the following solvents
  - Isopropyl alcohol
  - Ethyl alcoholDo not scrub hard to avoid damaging the display surface.
- (6) Solvents other than those above-mentioned may damage the polarizer. Especially, do not use the following.
  - Water
  - Ketone
  - Aromatic solventsWipe off saliva or water drops immediately, contact with water over a long period of time may cause deformation or color fading. Avoid contacting oil and fats.
- (7) Exercise care to minimize corrosion of the electrode. Corrosion of the electrodes is accelerated by water droplets, moisture condensation or a current flow in a high-humidity environment.
- (8) Install the LCD Module by using the mounting holes. When mounting the LCD module make sure it is free of twisting, warping and distortion. In particular, do not forcibly pull or bend the I/O cable or the backlight cable.
- (9) Do not attempt to disassemble or process the LCD module.
- (10) NC terminal should be open. Do not connect anything.
- (11) If the logic circuit power is off, do not apply the input signals.
- (12) Since LCM has been assembled and adjusted with a high degree of precision, avoid applying excessive shocks to the module or making any alterations or modifications to it.
  - Do not alter, modify or change the shape of the tab on the metal frame.
  - Do not make extra holes on the printed circuit board, modify its shape or change the positions of components to be attached.
  - Do not damage or modify the pattern writing on the printed circuit board.
  - Absolutely do not modify the zebra rubber strip (conductive rubber) or heat seal

connector.

- Except for soldering the interface, do not make any alterations or modifications with a soldering iron.
- Do not drop, bend or twist LCM.

## Storage Precautions

When storing the LCD modules, the following precaution is necessary.

- (1) Store them in a sealed polyethylene bag. If properly sealed, there is no need for the dessicant.
- (2) Store them in a dark place. Do not expose to sunlight or fluorescent light, keep the temperature between 0°C and 35°C.
- (3) The polarizer surface should not come in contact with any other objects. (We advise you to store them in the container in which they were shipped).

## Others

Liquid crystals solidify under low temperature (below the storage temperature range) leading to defective orientation or the generation of air bubbles (black or white). Air bubbles may also be generated if the module is subject to a low temperature.

If the LCD modules have been operating for a long time showing the same display patterns, the display patterns may remain on the screen as ghost images and a slight contrast irregularity may also appear. A normal operating status can be regained by suspending use for some time. It should be noted that this phenomenon does not adversely affect performance reliability.

To minimize the performance degradation of the LCD modules resulting from destruction caused by static electricity etc., exercise care to avoid holding the following sections when handling the modules.

- Exposed area of the printed circuit board.
- Terminal electrode sections.